

SEC. A-A

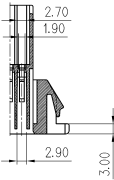

SEC. B-B

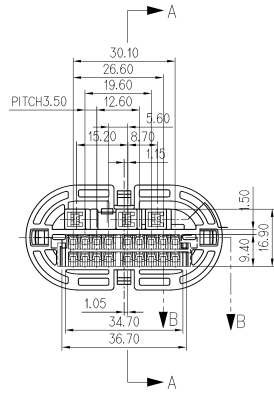
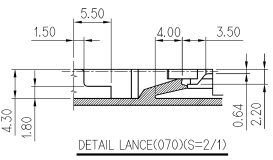
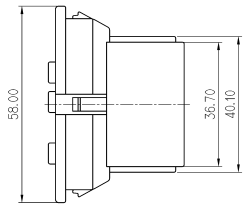
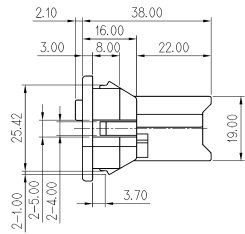
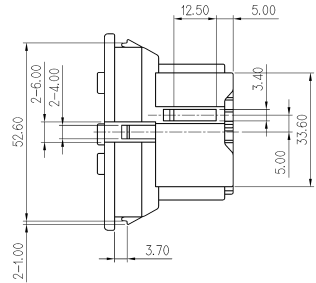

DETAIL LANCE(070)(XS=2/1)

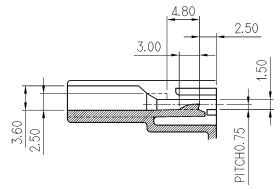

DETAIL LANCE(PAXS=2/1)

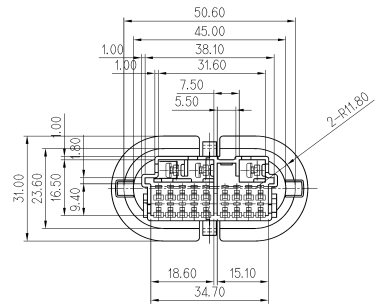

주 기

- 1.기능상 유해한 BURR 및 변형등이 없을 것.
- 2.CONNECTOR 규격: KET PA 3P + SDL 18P HYBRID
- 3.적용 PANEL: BODY쪽 t= 0.7, 24 X 51
DOOR쪽 t= 1.2, 24 X 51
- 4.적용 TERMINAL: PA(3mm) = ST740187 외 동일 SERIES
SDL(070) = ST740484 외 동일 SERIES



ISSUE MARK

						MATERIAL PBT		KOREA ELECTRIC TERMINAL CO., LTD.	
						FINISH NATURAL			
						WIRE RANGE		CLASS	
						INSULATION		TYPE	
LTR	REVISION RECORD	DR	CHK	APP.	DATE	WIRE RANGE DIFFERENT WIRE	SCALE	PART NO.	
DR.	WON. 93.10.18	CHK	WJ	APP.	10/20	± 0.2	1/1	MG620689	
CHK.		APP.	WJ	APP.	10/20				
PART NAME								DOOR CONNECTOR 21P RECP. HOUSING	