

10MAX	30MAX	50MAX	70MAX	100MAX	120MAX	250MAX	250VR	ANGLE	ECCENT
±0.15	±0.2	±0.3	±0.4	±0.5	±0.75	±0.9	±1.4	±30'	0.1

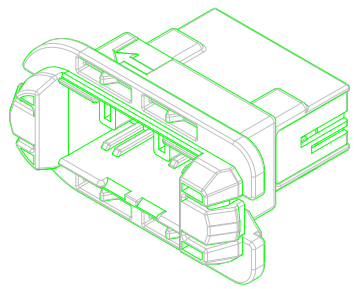

ISO VIEW

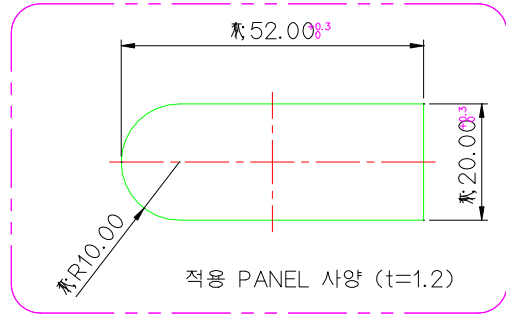
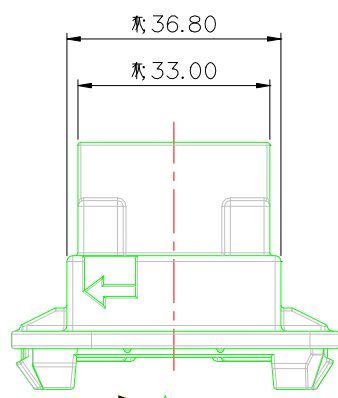

주 기

- 기능상 유해한 BURR 및 WELDLINE 등이 없을 것.
- 적용 TERMINAL(025II) : ST741345,741346-3
적용 TERMINAL(060) : ST741331,731332,731333-3
적용 TERMINAL(110) : ST741285,741286,741287-3
적용 CONNECTOR : MG655696
- 제품내 함유된 6대 유해물질 (납,수은,카드뮴,6가크롬, PBBs,PBDEs)은 EU ELV 지침 및 RoHS 법규에서 지정한 최대 허용 농도를 초과해서는 안된다.

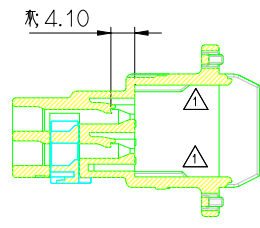
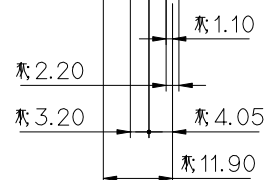
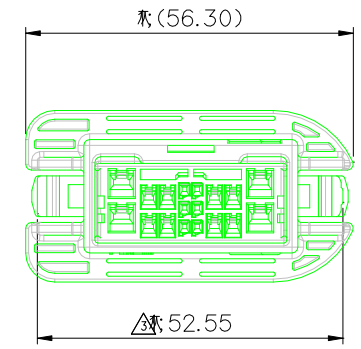
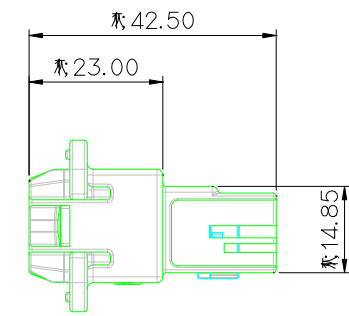
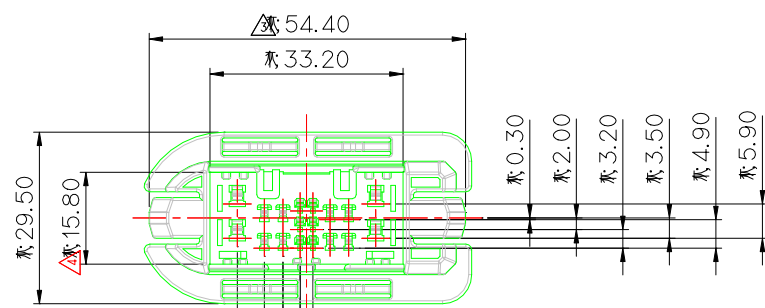
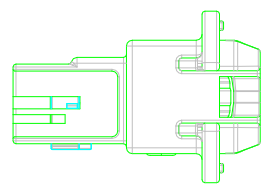

SECTION A-A

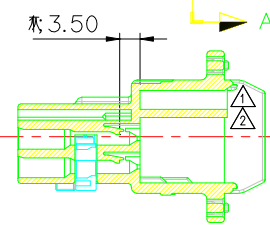

SECTION B-B

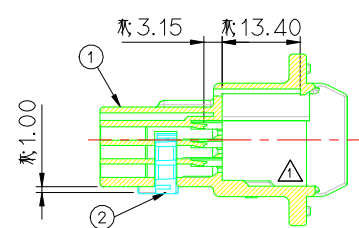

SECTION C-C

NOTE

- MUST BE FREE OF FLASH, WELDLINE AND IMPERFECTION THAT AFFECT FUNCTION.
- APPLICABLE TERMINAL(025II) : ST741345,741346-3
APPLICABLE TERMINAL(060) : ST741331,741332,741333-3
APPLICABLE TERMINAL(110) : ST741285,741286,741287-3
APPLICABLE CONNECTOR : MG655696
- 6 HAZARDOUS SUBSTANCES IN PARTS (LEAD, MERCURY, CADMIUM, HEXAVALENT CHROMIUM, PBBs, PBDEs) SHALL NOT EXCEED THE MAXIMUM PERMISSIBLE CONCENTRATION PRESCRIBED UNDER EU ELV DIRECTIVE & RoHS REGULATION.

APPROVED

2015-06-25

KOREA ELECTRIC
TERMINAL CO., LTD.
Connector Development Team 1

ISSUE MARK

NO.	PART NAME	PART NO.	MATERIAL	COLOR	QTY.
1	025060110 18M HOUSING	MG675866	PBT	NATURAL	1
2	025060110 18M SPACER	MG675867	PBT	L/GRAY	1

ECO-1503-566	근거 도면 수정	JH.K	WDH	KMH	LSY	15.04.07
ECO-1503-326	근거 도면 수정	JH.K	WDH	KMH	LSY	15.03.16
ECO-1406-232	근거 도면 수정	LJW	WDH	KMH	LSY	14.07.01
ECO-1405-133	근거 도면 수정	LJW	WDH	KMH	HJB	14.05.22
LTR	REVISION RECORD	DR.	CHK.	CHK.	APP.	DATE
DR.	WDH. 14.01.10	CHK.				
CHK.	KMH. 14.02.12	APP.	KMH.	14.02.12		

MATERIAL	SEE TABLE	KIET KOREA ELECTRIC TERMINAL CO., LTD. ENGINEERED
FINISH	SEE TABLE	
WIRE RANGE		CLASS HYBRID
INSULATION		TYPE 025/060/110
TOLERANCE EXCEPT AS NOTED	SEE TABLE	SCALE 1/1
PART NAME	025060110 18M ASSY	
		PART NO. MG645749

